

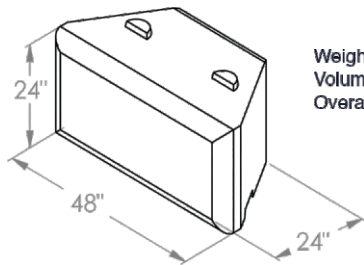

FULL BLOCK



Weight: 1750 lb (794 Kg)
Volume: 12.5 cft (0.4 m³)
Overall: 24 x 24 x 48 In

FULL CORNER

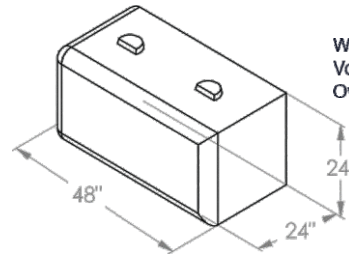

Weight: 2300 lb (1043 Kg)
Volume: 15.5 cft (0.4 m³)
Overall: 24 x 24 x 48 In

FULL BENCH

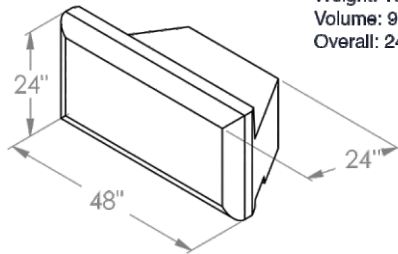

Weight: 1375 lb (623 Kg)
Volume: 9.6 cft (0.3 m³)
Overall: 24 x 24 x 48 In

FULL BENCH CORNER

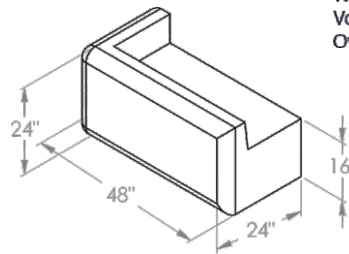

Weight: 1800 lb (816 Kg)
Volume: 12.11 cft (0.34 m³)
Overall: 24 x 24 x 48 In

FULL BLOCK

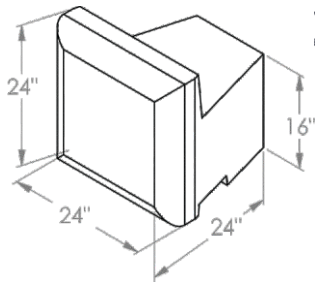

Weight: 695 lb (315 Kg)
Volume: 6.3 cft (0.15 m³)
Overall: 24 x 24 x 24 In

FULL CORNER

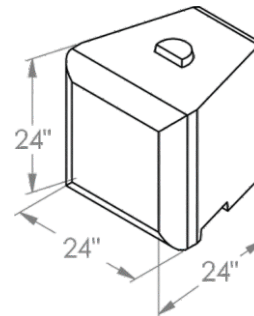

Weight: 905 lb (411 Kg)
Volume: 6.3 cft (0.2 m³)
Overall: 24 x 24 x 24 In

Need Help? Contact us today to request a quote or get more information about our products & services.

RED DEER PLANT Office: 403-343-8000
Toll Free: 800-859-5541

CALGARY PLANT Office: 403-261-3851
Toll Free: 800-859-5541

HEAD OFFICE Office: 403-343-6099
Toll Free: 800-859-5541



FREESTANDING BLOCKS

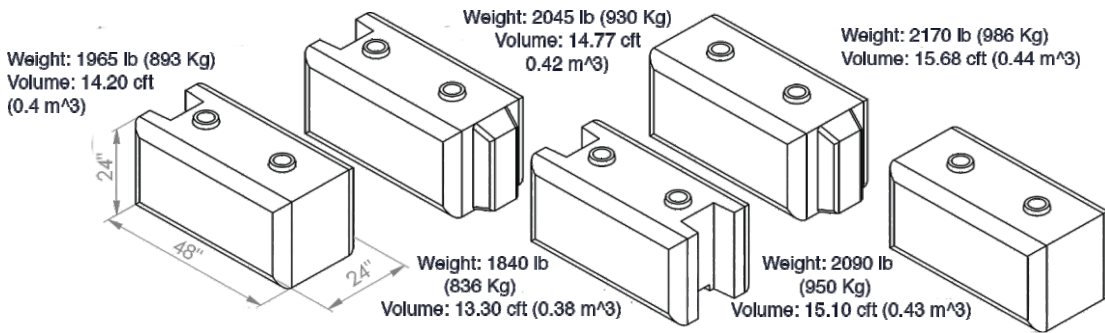

12" BLOCK

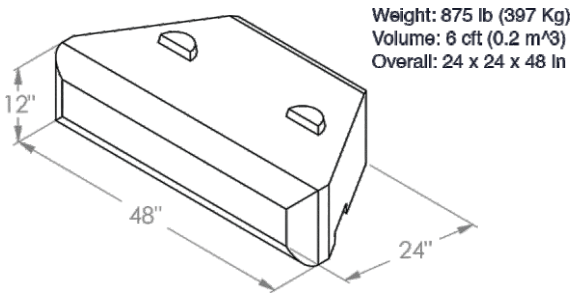

12" BENCH

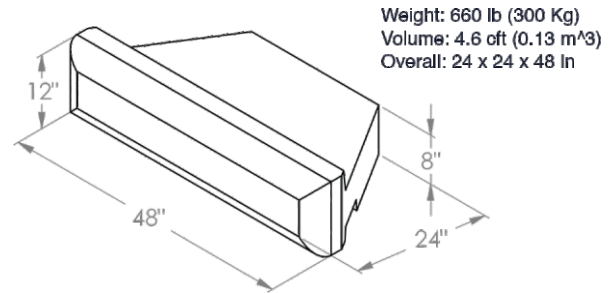

ULTIMATE CONNECTION BLOCK

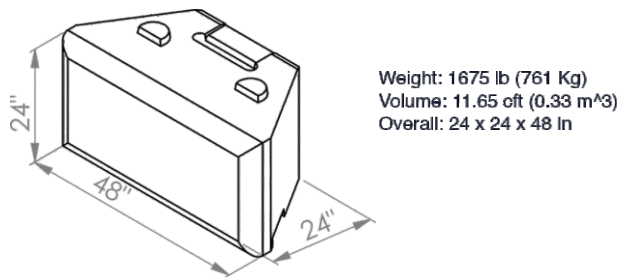

GRAVITY BLOCKS

48" BLOCK

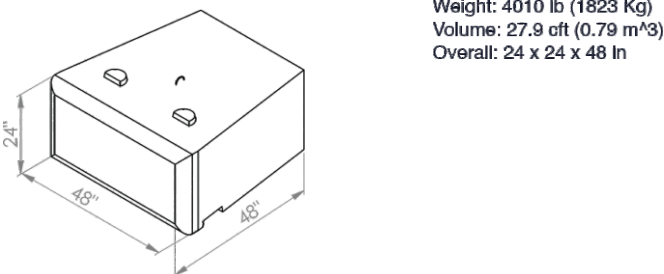

60" BENCH

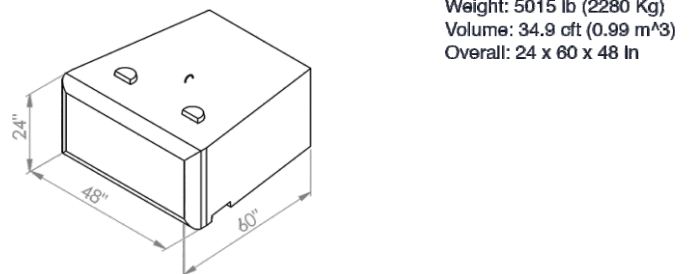

Need Help? Contact us today to request a quote or get more information about our products & services.

RED DEER PLANT Office: 403-343-8000
Toll Free: 800-859-5541

CALGARY PLANT Office: 403-261-3851
Toll Free: 800-859-5541

HEAD OFFICE Office: 403-343-6099
Toll Free: 800-859-5541

